

### Description

The APX823/APX824/APX825A family of supervisors provides circuit initialization and timing supervision, primarily for DSP and processor-based systems.

During power-on,  $\overline{\text{RESET}}$  is asserted when supply voltage  $V_{CC}$  becomes higher than 1.1V. Thereafter, the supply voltage supervisor monitors  $V_{CC}$  and keeps  $\overline{\text{RESET}}$  active as long as  $V_{CC}$  remains below the threshold voltage  $V_{TH}$ . An internal timer delays the return of the output to the inactive state (high) to ensure proper system reset. The delay time,  $t_d$  starts after  $V_{CC}$  has risen above the threshold voltage  $V_{TH}$ . When the supply voltage drops below the threshold voltage  $V_{TH}$ , the output becomes active (low) again. No external components are required. All the devices of this family have a fixed-sense threshold voltage  $V_{TH}$  set by an internal voltage divider.

The APX823/APX825A devices incorporate a manual reset input,  $\overline{\text{MR}}$ . A low level at  $\overline{\text{MR}}$  causes  $\overline{\text{RESET}}$  to become active. The APX824/APX825A devices include a high-level output RESET. APX823/APX824/APX825A have a watchdog timer that is periodically triggered by a positive or negative transition at WDI. When the supervising system fails to retrigger the watchdog circuit within the time-out interval,  $t_{out}$ ,  $\overline{\text{RESET}}$  becomes active for the time period  $t_d$ . This event also reinitializes the watchdog timer. Leaving WDI unconnected disables the watchdog.

In applications where the input to the WDI pin may be active (transitioning high and low) when the APX823/APX824/APX825A asserting  $\overline{\text{RESET}}$  the APX823/APX824/APX825A does not return to a non-reset state when the input voltage is above  $V_t$ . The product spectrum is designed for supply voltage of 2.5V, 3V, 3.3V and 5V. The circuits are available in a SOT25 and SOT26 packages. The APX823/APX824/APX825A devices are characterized for operation over a temperature range of  $-40^{\circ}\text{C}$  to  $105^{\circ}\text{C}$ .

### Features

- Power-on reset generator with fixed delay time of 200ms Typ
- Manual reset input (APX823/APX825A)
- Reset output available in active-low (APX823/APX824/APX825A), active-high (APX824/APX825A)
- Supply voltage supervision range 2.5V, 3V, 3.3V, 5V
- Watchdog timer
- Supply current of 30 $\mu\text{A}$  (Typ.)
- Temperature range:  $-40^{\circ}\text{C}$  to  $85^{\circ}\text{C}$
- SOT25 and SOT26: Available in "Green" Molding Compound (No Br, Sb)
- Lead Free Finish/RoHS Compliant (Note 1)

Note: 1. EU Directive 2002/95/EC (RoHS). All applicable RoHS exemptions applied, see *EU Directive 2002/95/EC Annex Notes*.

### Pin Assignments

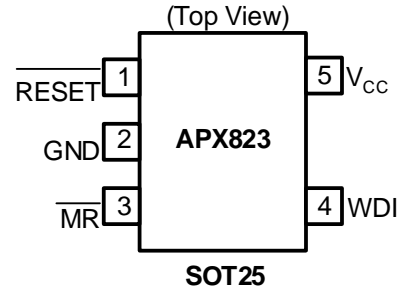

### Applications

- Applications Using DSPs, Microcontrollers, or Microprocessors
- Industrial Equipment
- Programmable Controls
- Automotive Systems
- Portable/Battery-Powered Equipment
- Intelligent Instruments
- Wireless Communications Systems
- Notebook/Desktop Computers

**Typical Application Circuit**



**Pin Descriptions**

Pin Name	Description
GND	Ground
RESET (RESET)	Reset output pin
V <sub>CC</sub>	Operating voltage input
WDI	Watchdog input
MR	Manual reset

**Functional Block Diagram**



\* APX824/APX825A  
\*\* APX823/APX825A

### Absolute Maximum Ratings (Over operating ambient temperature range, unless otherwise noted)\*

Symbol	Parameter		Rating	Unit	
ESD HBM	Human Body Model ESD Protection		5	KV	
ESD MM	Machine Model ESD Protection		200	V	
V <sub>CC</sub>	Supply Voltage		6.0	V	
V <sub>RESET</sub>	RESET, $\overline{\text{RESET}}$ , $\overline{\text{MR}}$ , WDI		-0.3 to (V <sub>CC</sub> +0.3)	V	
I <sub>CC</sub>	Input Current V <sub>CC</sub>		20	mA	
I <sub>O</sub>	Maximum High Output Current		20	mA	
P <sub>D</sub>	Continuous Total Power Dissipation	Derating Factor Above T <sub>A</sub> = 25°C	SOT25	6.2	mW/°C
			SOT26	5.8	
		T <sub>A</sub> = 25°C Power Rating	SOT25	500	mW
			SOT26	470	
		T <sub>A</sub> = 70°C Power Rating	SOT25	220	mW
			SOT26	210	
		T <sub>A</sub> = 85°C Power Rating	SOT25	125	mW
			SOT26	120	
T <sub>OP</sub>	Operating Junction Temperature Range		-40 to 105	°C	
T <sub>ST</sub>	Storage Temperature Range		-65 to 150	°C	

\* Stresses beyond those listed under "absolute maximum ratings" may cause permanent damage to the device. These are stress ratings only, and functional operation of the device at these or any other conditions beyond those indicated under "recommended operating conditions" is not implied. Exposure to absolute-maximum-rated conditions for extended periods may affect device reliability.

### Recommended Operating Conditions

Symbol	Parameter	Min	Max	Unit
V <sub>CC</sub>	Supply Voltage	1.1	5.5	V
V <sub>IN</sub>	Input Voltage	0	(V <sub>CC</sub> +0.3)	V
V <sub>IH</sub>	High-level Input Voltage at $\overline{\text{MR}}$ and WDI	0.7 × V <sub>CC</sub>	-	V
V <sub>IL</sub>	Low-level Voltage	-	0.3 × V <sub>CC</sub>	V
Δt/ΔV	Input Transition Rise and Fall Rate at $\overline{\text{MR}}$ or WDI	-	100	ns/V
T <sub>A</sub>	Operating Ambient Temperature Range	-40	85	°C
T <sub>R</sub>	V <sub>CC</sub> Rising Time (V <sub>CC</sub> = 0~VT)	-	100	V/ μS

### Electrical Characteristics (Over recommended operating ambient temperature range, unless otherwise noted)

Symbol	Parameter		Test Conditions	Min	Typ.	Max	Unit															
V <sub>OH</sub>	High-level Output Voltage	RESET	APX823/APX824/APX825A - 29/26/23	V <sub>CC</sub> = V <sub>TH</sub> + 0.2V I <sub>OH</sub> = -20μA	0.8 × V <sub>CC</sub>	-	-	V														
			APX823/APX824/APX825A - 40/31	V <sub>CC</sub> = V <sub>TH</sub> + 0.2V I <sub>OH</sub> = -30μA																		
		RESET	APX823/APX824/APX825A - 46/44	V <sub>CC</sub> = V <sub>TH</sub> + 0.2V I <sub>OH</sub> = -120μA	V <sub>CC</sub> - 1.5V	-	-	V														
			APX824/APX825A - 29/26/23	V <sub>CC</sub> ≥ 1.8V, I <sub>OH</sub> = -100μA	0.8 × V <sub>CC</sub>	-	-	V														
APX824/APX825A - 46/44/40/31	V <sub>CC</sub> ≥ 1.8V, I <sub>OH</sub> = -150μA																					
V <sub>OL</sub>	Low-level Output Voltage	RESET	APX824/APX825A - 29/26/23	V <sub>CC</sub> = V <sub>TH</sub> + 0.2V I <sub>OL</sub> = 1mA	-	-	0.4	V														
			APX824/APX825A - 40/31	V <sub>CC</sub> = V <sub>TH</sub> + 0.2V I <sub>OL</sub> = 1.2mA																		
			APX824/APX825A - 46/44	V <sub>CC</sub> = V <sub>TH</sub> + 0.2V I <sub>OL</sub> = 3mA																		
		RESET	APX823/APX824/APX825A - 29/26/23	V <sub>CC</sub> = V <sub>TH</sub> - 0.2V I <sub>OL</sub> = 1mA	-	-	0.4	V														
			APX823/APX824/APX825A - 40/31	V <sub>CC</sub> = V <sub>TH</sub> - 0.2V I <sub>OL</sub> = 1.2mA																		
			APX823/APX824/APX825A - 46/44	V <sub>CC</sub> = V <sub>TH</sub> - 0.2V I <sub>OL</sub> = 3mA																		
V <sub>RESET</sub>	Power-up Reset Voltage (see Note 2)		V <sub>CC</sub> ≥ 1.1V, I <sub>OL</sub> = 20μA	-	-	0.4	V															
V <sub>TH-</sub>	Negative-going Input Threshold Voltage (see Note 3)	T <sub>A</sub> = 0°C - 85°C	APX823/APX824/APX825A - 23	2.21	2.25	2.30	V															
			APX823/APX824/APX825A - 26					2.59	2.63	2.69												
			APX823/APX824/APX825A - 29								2.88	2.93	3.00									
			APX823/APX824/APX825A - 31											3.02	3.08	3.15						
			APX823/APX824/APX825A - 40														3.93	4.00	4.08			
			APX823/APX824/APX825A - 44																	4.31	4.38	4.47
			APX823/APX824/APX825A - 46																			
		APX823/APX824/APX825A - 23	2.20	2.25	2.30																	
		APX823/APX824/APX825A - 26				2.57	2.63	2.69														
		APX823/APX824/APX825A - 29							2.86	2.93	3.00											
		APX823/APX824/APX825A - 31										3.00	3.08	3.15								
		APX823/APX824/APX825A - 40													3.92	4.00	4.08					
		APX823/APX824/APX825A - 44																4.29	4.38	4.47		
		APX823/APX824/APX825A - 46																			4.54	4.63
T <sub>A</sub> = -40°C - 85°C																						

Note: 2. The lowest supply voltage at which RESET becomes active. T<sub>R</sub>, V<sub>CC</sub> ≥ 15μs/V.

3. To ensure best stability of the threshold voltage, a bypass capacitor (ceramic, 0.1μF) should be placed near the supply terminals.

### Electrical Characteristics (cont.)

Symbol	Parameter		Test Conditions	Min	Typ.	Max	Unit
$V_{hys}$	Hysteresis at $V_{CC}$ Input	APX823/APX824/APX825A -23		-	50	-	mV
		APX823/APX824/APX825A -26					
		APX823/APX824/APX825A -29					
		APX823/APX824/APX825A -31					
		APX823/APX824/APX825A -40					
		APX823/APX824/APX825A -44					
		APX823/APX824/APX825A -46					
$T_S$	Set-up Time	$V_{CC} = V_{TH}$ to $(V_{TH} - 100mV)$			20		$\mu s$
$I_{IH(AV)}$	Average High-level Input Current	WDI	WDI= $V_{CC}$ , Time average (dc=88%)	-	120	-	$\mu A$
$I_{IL(AV)}$	Average Low-level Input Current		WDI=0.3V, $V_{CC}$ =5.5V time average (dc=12%)	-	-15	-	$\mu A$
$I_{IH}$	High-level Input Current	WDI	WDI= $V_{CC}$	-	120	160	$\mu A$
$I_{IL}$	Low-level Input Current	WDI	WDI=0.3V, $V_{CC}$ =5.5V	-	120	160	$\mu A$
$I_{CC}$	Supply Current	WDI and MR Unconnected, Outputs unconnected	$V_{CC} = \underline{V_{TH}}+0.2V$	-	30	40	$\mu A$
	Internal Pull-up Resistor at MR			-	60	-	k $\Omega$
TC	$V_{OUT}$ Temperature Coefficient				50	-	ppm/ $^{\circ}C$
$C_i$	Input Capacitance at MR, WDI		$V_I = 0V$ to 5.5V	-	5	-	pF
$\theta_{JA}$	Thermal Resistance Junction-to-Ambient		SOT25 (Note 4)		161		$^{\circ}C/W$
			SOT26 (Note 4)		169		
$\theta_{JC}$	Thermal Resistance Junction-to-Case		SOT25 (Note 4)		27		$^{\circ}C/W$
			SOT26 (Note 4)		28		

Note: 4. Test condition for SOT25 and SOT26: Devices mounted on FR-4 substrate PC board, 2oz copper, with minimum recommended pad layout.

### Timing Requirements (@ $R_L = 1\text{m}\Omega$ , $C_L = 50\text{pF}$ , $T_A = 25^\circ\text{C}$ )

Symbol	Parameter	Test Conditions	Min	Typ.	Max	Unit	
$t_w$	Pulse Width	at $\overline{\text{MR}}$	$V_{CC} \geq \underline{V_{TH}} + 0.2\text{V}$ , $V_{IL} = 0.3 \times V_{CC}$ , $V_{IH} = 0.7 \times V_{CC}$	<u>100</u>	-	-	ns
		at $\overline{\text{WDI}}$	$V_{CC} \geq \underline{V_{TH}} + 0.2\text{V}$ , $V_{IL} = 0.3 \times V_{CC}$ , $V_{IH} = 0.7 \times V_{CC}$	<u>50</u>	-	-	ns

### Switching Characteristics (@ $R_L = 1\text{m}\Omega$ , $C_L = 50\text{pF}$ , $T_A = 25^\circ\text{C}$ )

Symbol	Parameter	Test Conditions	Min	Typ.	Max	Unit	
$t_{\text{out}}$	Watchdog Time Out	APX823/APX824/APX825A $V_{CC} \geq \underline{V_{TH}} + 0.2\text{V}$ , See timing diagram	<u>1.12</u>	1.6	<u>2.4</u>	s	
$t_d$	Delay Time	APX823/APX824/APX825A $V_{CC} \geq \underline{V_{TH}} + 0.2\text{V}$ , See timing diagram	140	200	280	ms	
$t_{\text{PHL}}$	Propagation (Delay) Time, High-to-low-level Output	$\overline{\text{MR}}$ to $\overline{\text{RESET}}$ delay (APX823/APX825A)	$V_{CC} > \underline{V_{TH}} + 0.2\text{V}$ , $V_{IL} = 0.3 \times V_{CC}$ , $V_{IH} = 0.7 \times V_{CC}$	-	-	0.1	$\mu\text{s}$
		$V_{CC}$ to $\overline{\text{RESET}}$ delay	$V_{IL} = \underline{V_{TH}} - 0.2\text{V}$ , $V_{IH} = \underline{V_{TH}} + 0.2\text{V}$	-	-	25	$\mu\text{s}$
$t_{\text{PLH}}$	Propagation (Delay) Time, Low-to-high-level Output	$\overline{\text{MR}}$ to $\overline{\text{RESET}}$ delay (APX824/APX825A)	$V_{CC} > \underline{V_{TH}} + 0.2\text{V}$ , $V_{IL} = 0.3 \times V_{CC}$ , $V_{IH} = 0.7 \times V_{CC}$	-	-	0.1	$\mu\text{s}$
		$V_{CC}$ to $\overline{\text{RESET}}$ delay (APX824/APX825A)	$V_{IL} = \underline{V_{TH}} - 0.2\text{V}$ , $V_{IH} = \underline{V_{TH}} + 0.2\text{V}$	-	-	25	$\mu\text{s}$

**Timing Diagram**

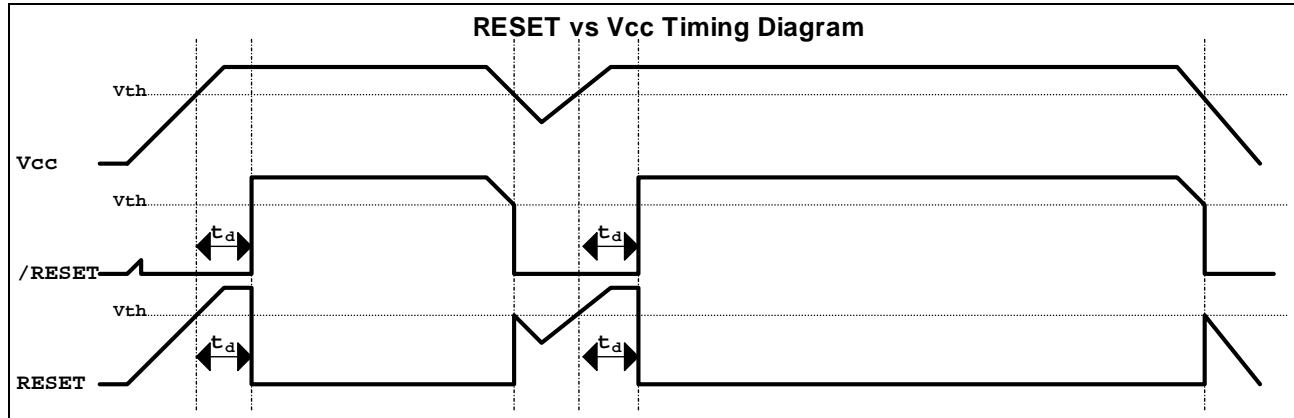

**Typical Characteristics**

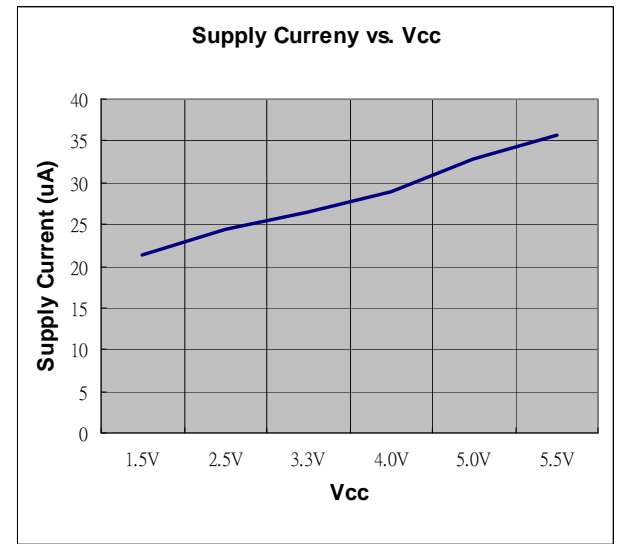
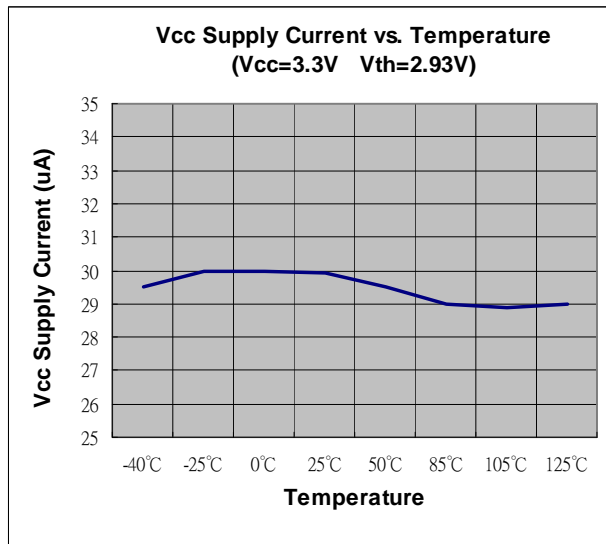
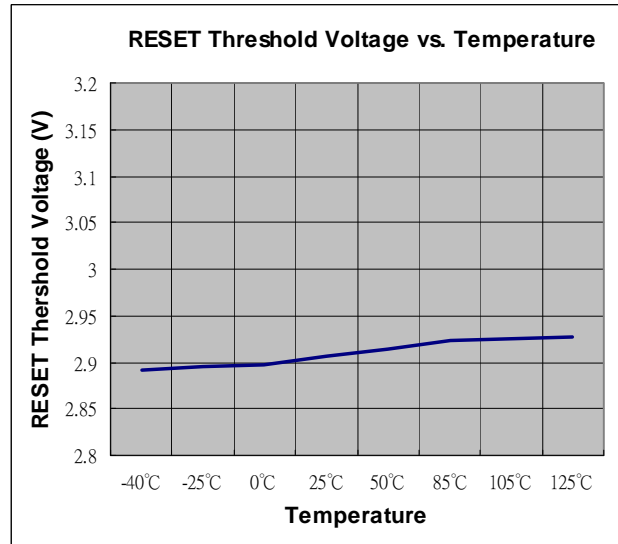
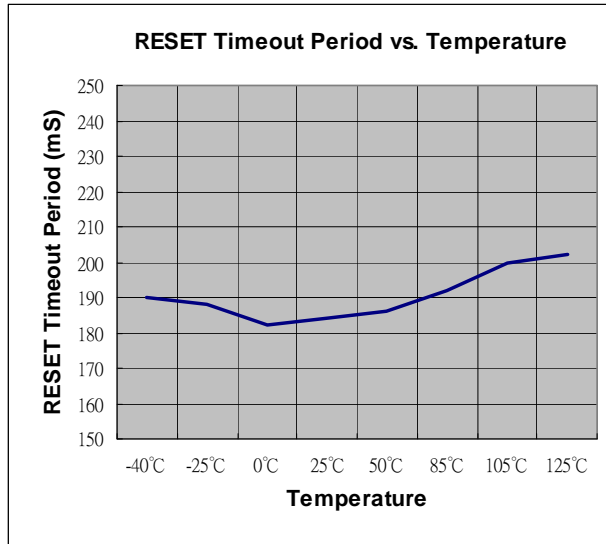



**Ordering Information**

**APX82 XX - XX XX G - Z**

Part No.	Voltage	Package	Green	Packing
3 : APX823	46 : 4.63	W5 : SOT25	G : Green	7 : Tape & Reel
4 : APX824	44 : 4.38	W6 : SOT26		
5A : APX825A	40 : 4.00			
	31 : 3.08			
	29 : 2.93			
	26 : 2.63			
	23 : 2.25			

Device	Package Code	Packaging (Note 5)	7" Tape and Reel	
			Quantity	Part Number Suffix
 APX823-XXW5G-7	W5	SOT25	3000/Tape & Reel	-7
 APX824-XXW5G-7	W5	SOT25	3000/Tape & Reel	-7
 APX825A-XXW6G-7	W6	SOT26	3000/Tape & Reel	-7

Notes: 5. Pad layout as shown on Diodes Inc. suggested pad layout document AP02001, which can be found on our website at <http://www.diodes.com/datasheets/ap02001.pdf>.

**Marking Information**

**(1) SOT25**

**( Top View )**



**XX** : Identification code  
**Y** : Year 0~9  
**W** : Week : A~Z : 1~26 week;  
a~z : 27~52 week; z represents  
52 and 53 week  
**X** : A~Z : Green

**(2) SOT26**

**( Top View )**

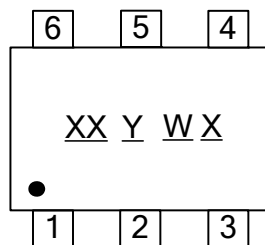

**XX** : Identification code  
**Y** : Year 0~9  
**W** : Week : A~Z : 1~26 week;  
a~z : 27~52 week; z represents  
52 and 53 week  
**X** : A~Z : Green

**Marking Information (cont.)**

**Marking Table**

Device	Package Type	Identification Code
APX823-46W5	SOT25	W1
APX823-44W5	SOT25	W2
APX823-40W5	SOT25	W3
APX823-31W5	SOT25	W4
APX823-29W5	SOT25	W5
APX823-26W5	SOT25	W6
APX823-23W5	SOT25	W7
APX824-46W5	SOT25	T2
APX824-44W5	SOT25	T3
APX824-40W5	SOT25	T4
APX824-31W5	SOT25	T5
APX824-29W5	SOT25	T6
APX824-26W5	SOT25	T7
APX824-23W5	SOT25	T8
APX825A-46W6	SOT26	T9
APX825A-44W6	SOT26	TA
APX825A-40W6	SOT26	TB
APX825A-31W6	SOT26	TC
APX825A-29W6	SOT26	TD
APX825A-26W6	SOT26	TE
APX825A-23W6	SOT26	TF

**Package Outline Dimensions (All Dimensions in mm)**

**(1) Package Type: SOT25**



**Package Outline Dimensions (cont.) (All Dimensions in mm)**

**(2) Package Type: SOT26**

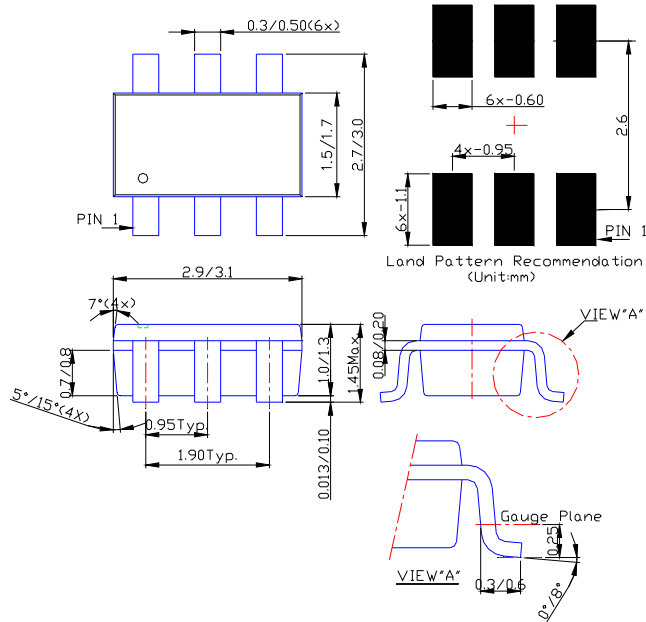

Notes: 6. Package outline dimensions as shown on Diodes Inc. package outline dimensions document AP02002, which can be found on our website at <http://www.diodes.com/datasheets/ap02002.pdf>

**IMPORTANT NOTICE**

DIODES INCORPORATED MAKES NO WARRANTY OF ANY KIND, EXPRESS OR IMPLIED, WITH REGARDS TO THIS DOCUMENT, INCLUDING, BUT NOT LIMITED TO, THE IMPLIED WARRANTIES OF MERCHANTABILITY AND FITNESS FOR A PARTICULAR PURPOSE (AND THEIR EQUIVALENTS UNDER THE LAWS OF ANY JURISDICTION).

Diodes Incorporated and its subsidiaries reserve the right to make modifications, enhancements, improvements, corrections or other changes without further notice to this document and any product described herein. Diodes Incorporated does not assume any liability arising out of the application or use of this document or any product described herein; neither does Diodes Incorporated convey any license under its patent or trademark rights, nor the rights of others. Any Customer or user of this document or products described herein in such applications shall assume all risks of such use and will agree to hold Diodes Incorporated and all the companies whose products are represented on Diodes Incorporated website, harmless against all damages.

Diodes Incorporated does not warrant or accept any liability whatsoever in respect of any products purchased through unauthorized sales channel.

Should Customers purchase or use Diodes Incorporated products for any unintended or unauthorized application, Customers shall indemnify and hold Diodes Incorporated and its representatives harmless against all claims, damages, expenses, and attorney fees arising out of, directly or indirectly, any claim of personal injury or death associated with such unintended or unauthorized application.

Products described herein may be covered by one or more United States, international or foreign patents pending. Product names and markings noted herein may also be covered by one or more United States, international or foreign trademarks.

**LIFE SUPPORT**

Diodes Incorporated products are specifically not authorized for use as critical components in life support devices or systems without the express written approval of the Chief Executive Officer of Diodes Incorporated. As used herein:

A. Life support devices or systems are devices or systems which:

1. are intended to implant into the body, or
2. support or sustain life and whose failure to perform when properly used in accordance with instructions for use provided in the labeling can be reasonably expected to result in significant injury to the user.

B. A critical component is any component in a life support device or system whose failure to perform can be reasonably expected to cause the failure of the life support device or to affect its safety or effectiveness.

Customers represent that they have all necessary expertise in the safety and regulatory ramifications of their life support devices or systems, and acknowledge and agree that they are solely responsible for all legal, regulatory and safety-related requirements concerning their products and any use of Diodes Incorporated products in such safety-critical, life support devices or systems, notwithstanding any devices- or systems-related information or support that may be provided by Diodes Incorporated. Further, Customers must fully indemnify Diodes Incorporated and its representatives against any damages arising out of the use of Diodes Incorporated products in such safety-critical, life support devices or systems.

Copyright © 2011, Diodes Incorporated

[www.diodes.com](http://www.diodes.com)